

# QUICK START GUIDE Room Unit

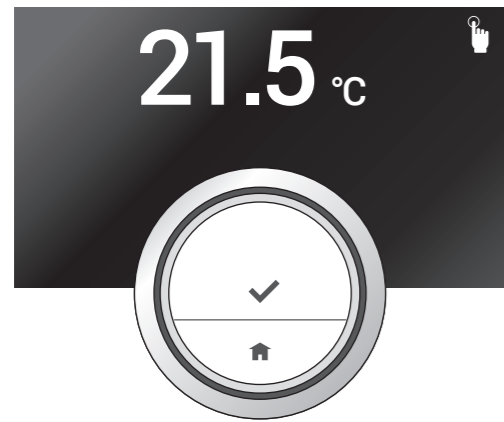

GUIA RÁPIDA DE INSTALACIÓN termostato ambiente  
GUIDA RAPIDA - Mago  
SNELSTART GIDS Thermostaat  
GUIDE DE PRISE EN MAIN RAPIDE  
KURZANLEITUNG Raumgerät  
GUIA RÁPIDO INSTALAÇÃO termostato ambiente

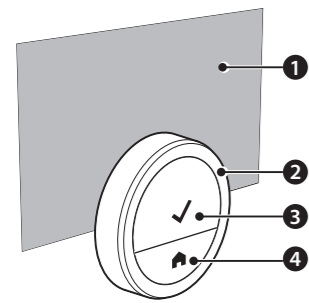

- 1 Display
- 2 Rotary dial (scroll and adjust)
- 3 Upper push button (select, confirm)
- 4 Lower push button (back, home)

- 1 Pantalla
- 2 Selector rotativo
- 3 Pulsador Superior (seleccionar, confirmar)
- 4 Pulsador Inferior (retroceder, inicio)

- 1 Afficheur
- 2 Bouton rotatif (navigation et réglage)
- 3 Bouton supérieur (sélectionner, confirmer)
- 4 Bouton inférieur (retour, accueil)

- 1 Display
- 2 Manopola
- 3 Pulsante alto: seleziona/confirm
- 4 Pulsante basso: torna indietro/menu principale

- 1 Display
- 2 Drehknopf
- 3 Oberer Taster (Auswahl, Bestätigung)
- 4 Unterer Taster (Zurück, Startbildschirm)

- 1 Display
- 2 Draaiknop (navigeren en aanpassen)
- 3 Bovenste drukknop (selecteren, bevestigen)
- 4 Onderste drukknop (terug, home)

- 1 Ecrã
- 2 Seletor rotativo (rolar e ajustar)
- 3 Tecla superior (seleccionar, confirmar)
- 4 Tecla inferior (retroceder, início)



**Consult online manual**  
Consultar manual online  
Vedi il manuale online  
Raadpleeg online handleiding  
Consulter le manuel en ligne  
Zur Online- Bedienungsanleitung  
Consultar manual online

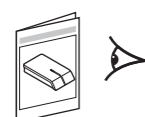

**Consult gateway manual**  
Consultar manual interface  
Vedi il manuale del kit adattatore  
Raadpleeg handleiding gateway  
Consulter le manuel du Gate Way  
Zur Bedienungsanleitung  
der Schnittstelle  
Consultar manual gateway  
(interface)



**Consult boiler manual**  
Consultar manual de la caldera  
Vedi il manuale di caldaia  
Raadpleeg ketel handleiding  
Consulter le manuel de  
la chaudière  
Zur Bedienungsanleitung  
des Kessels  
Consultar manual caldeira

## 1 HOW TO INSTALL?

CÓMO SE INSTALA?  
COME INSTALLARE MAGO?  
HOE TE INSTALLEREN?

COMMENT INSTALLER?  
INSTALLATION  
COMO INSTALAR?

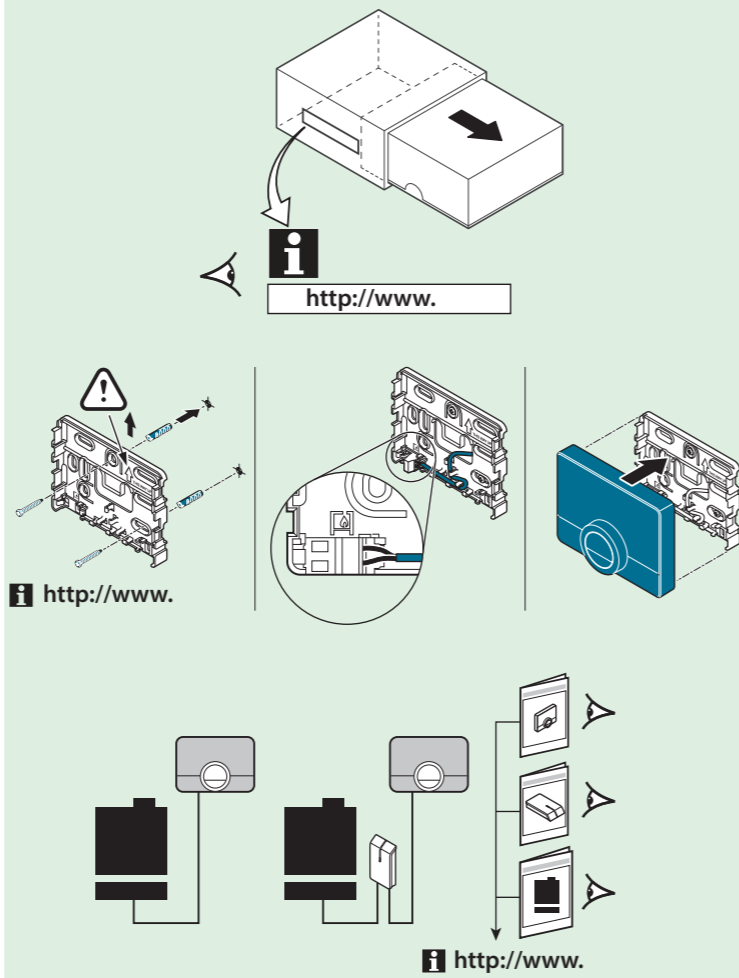

## 2 HOW TO USE?

CÓMO SE USA?  
COME USARE MAGO?  
HOE TE GEBUIKEN?

COMMENT UTILISER?  
BEDIENUNG  
COMO UTILIZAR?

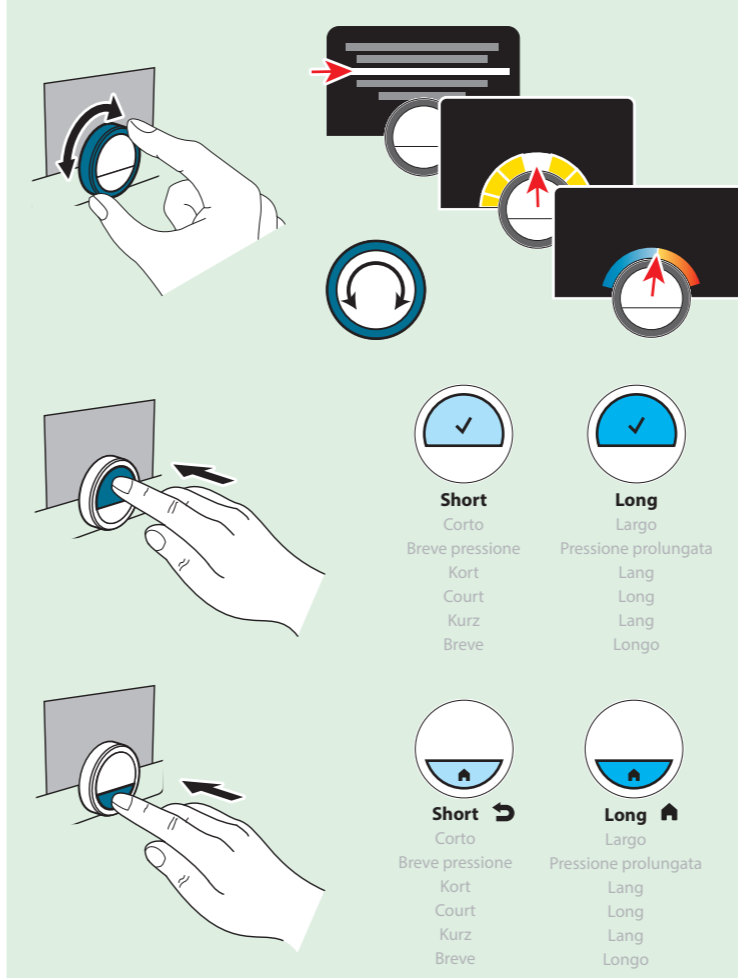

## 3 HOW TO OPERATE?

CÓMO FUNCIONA?  
FUNZIONI PRINCIPALI DI MAGO?

HOE TE BEDIENEN?  
COMMENT FAIRE FONCTIONNER?

BETRIEB  
COMO OPERAR?

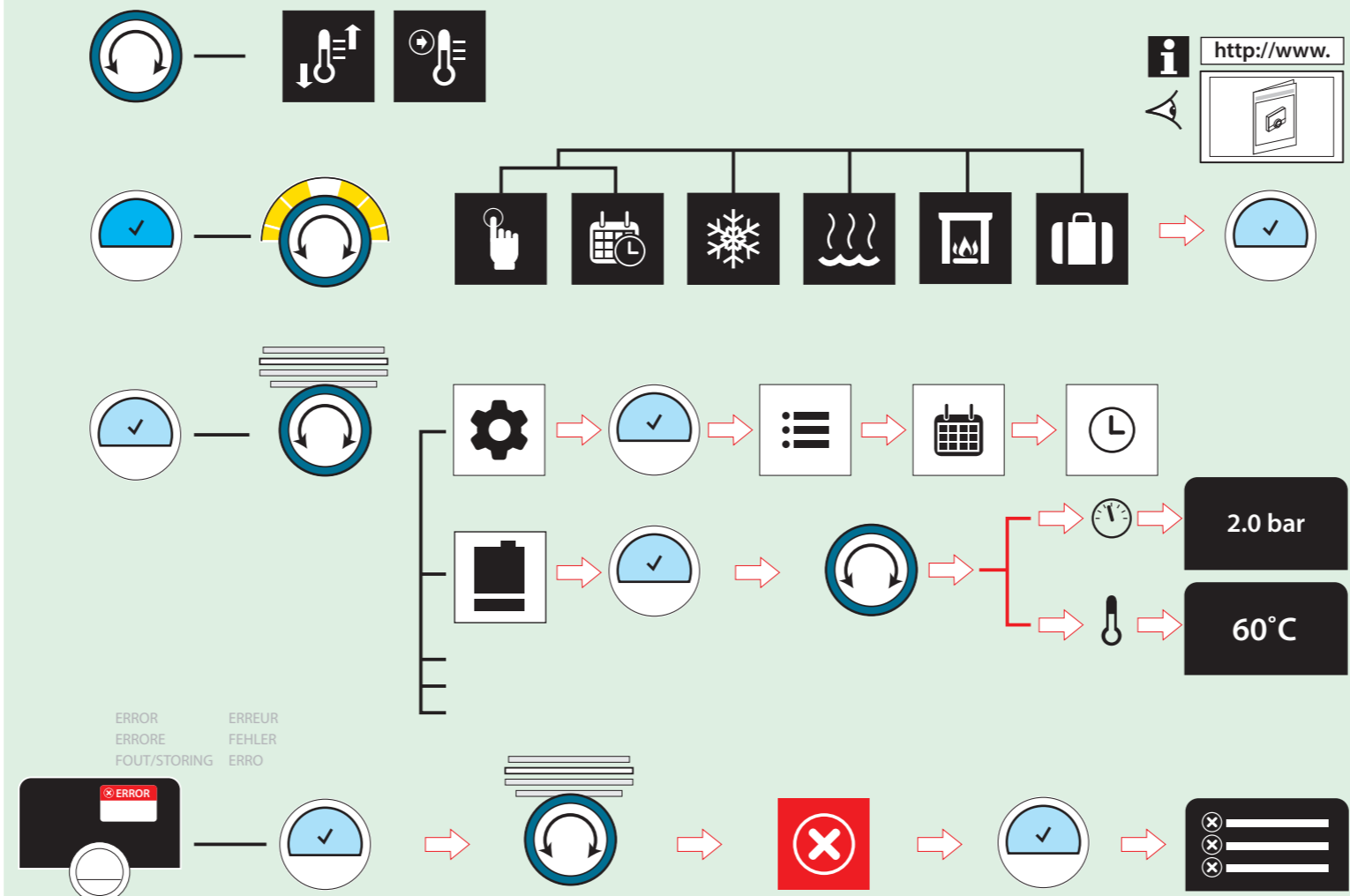

## GLOSSARY

GLOSSÁRIO

LEGENDA

LEGENDA



**Short (< 1 sec)**  
Presionar (<1 seg)  
Breve pressione (< 1 sec)  
Kort (< 1 sec)  
Court (< 1 sec)  
Kurz (< 1 sec)  
Breve (< 1 seg)



**Long (> 1 sec)**  
Mantener presionado (>1seg)  
Pressione prolungata (> 1 sec)  
Lang (> 1 sec)  
Long (> 1 sec)  
Lang (> 1 sec)  
Longo (>1 seg)

## Room unit icons

Icones del termostato ambiente  
Icône di Baxi Mago  
Thermostaat iconen

Les Icones du Room Unit  
Raumgerät Symbole  
Icones termostato ambiente

	<b>Manual</b> Manual Funzionamento in modalità manuale Handmatig Manuel Handbetrieb Manual		<b>Fireplace</b> Chimenea Modalità "caminetto" Openhaard Cheminée Kamin Lareira
	<b>Scheduling</b> Programación Funzionamento in modalità programmata Klokprogramma Programmation Zeitprogramm Programação horária		<b>Holiday</b> Vacaciones Modalità vacanza Vakantie Vacances Ferienprogramm Férias
	<b>Frost protection</b> Protección Anti-hielo Funzionamento in modalità antigelo Vorstbeveiligd Hors gel Frostschutz Proteção antigelo		<b>Short temperature change</b> Cambio Temporal de Temperatura Cambio di temperatura per un breve periodo Tijdelijke temperatuuraanpassing Dérogation temporaire de temp. Kurzeitige Temperaturänderung Alteração temperatura pontual
	<b>Hot water boost</b> Aceleración agua caliente Boost Acqua Calda (dove previsto) Warmwater boost Boost Eau Chaude Sanitaire Warmwasser Forçar água quente		<b>Target temperature</b> Temperatura deseada Temperatura impostata Ingestelde temperatuur Température de consigne Gewünschte Temperatur Temperatura de ajuste

	<b>Next step</b> Proximo Paso Passaggio successivo Volgende stap Etape suivante Weiter Próximo passo		<b>Confirm / Accept</b> Confermar / Accetar Conferma/acchetta Bevestigen/accepteren Confirmer / Valider Bestätigung Confirmar/aceitar
	<b>Selection</b> Selección Selezione Selectie Sélection Auswahl Selecionar		<b>Pressure</b> Presión Pressione Druk Pression Druck Pressão
	<b>Home</b> Inicio Home Home Accueil Startbildschirm Inicio		<b>Set time</b> Definir hora Impostazione data/ora Tijd instellen Régler l'heure Einstellung Uhrzeit Introduzir hora
	<b>Current temperature</b> Temperatura ambiente Temperatura attuale Gemeten temperatuur Température actuelle Aktuelle Temperatur Temperatura atual		<b>Error</b> Error Errore Fout/storing Erreur Fehler Erro
	<b>Set date</b> Definir fecha Impostazione data/ora Datum instellen Régler la date Einstellung Datum Introduzir data		<b>Connect to wifi</b> Conectar a la WI-FI Connessione wi-fi Verbinden met wifi Connecter au WIFI Verbindung zum WIFI Ligar wifi
	<b>Menu</b> Menü Menu Menu Menu Menu Menu		<b>E-mail</b> E-mail E-mail E-mail E-mail E-mail E-mail
	<b>Settings</b> Configuración Impostazioni Instellingen Paramètres Einstellungen Parametrização		<b>Device</b> Aparato Caldaia/generatore Apparaat Appareil Gerät Aparelho
	<b>Back</b> Retroceder Indietro Terug Retour Zurück Retroceder		<b>Register account / login</b> Registrar cuenta / Iniciar Sesión Registrazione / login account utente Account registreren / inloggen Créer un compte / Identification Nutzerkonto anlegen / Login Registrar conta/Iniciar sessão
	<b>Register phone or device</b> Registrar telefono o dispositivo Registra dispositivo (telefono/tablet) Smartphone of tablet registreren Enregistrer téléphone ou appareil Mobiltelefon oder Gerät anlegen Registrar telefone ou aparelho		

#### 4 HOW TO CONNECT TO WI-FI?

CÓMO CONECTAR A LA WIFI?  
COME CONNETTERE MAGO AL WI-FI DOMESTICO

HOE TE VERBINDEN MET WIFI?  
COMMENT SE CONNECTER AU WIFI

VERBINDUNG ZUM WIFI  
COMO LIGAR AO WI-FI

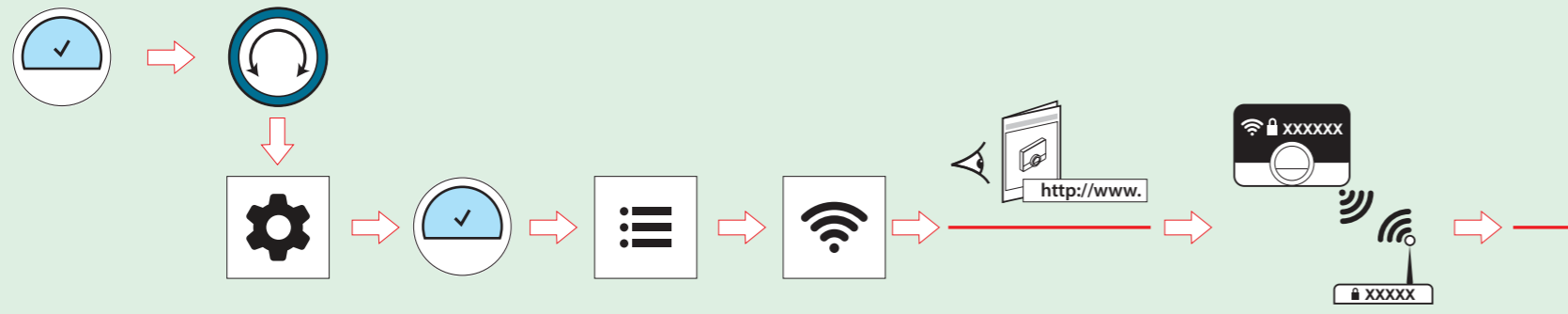

#### 5 DOWNLOAD THE APP

DESCARGAR LA APP  
SCARICARE LA APP DEDICATA

APP DOWNLOADEN  
TELECHARGER L'APPLICATION

HERUNTERLADEN DER APP  
DESCARREGAR A APP

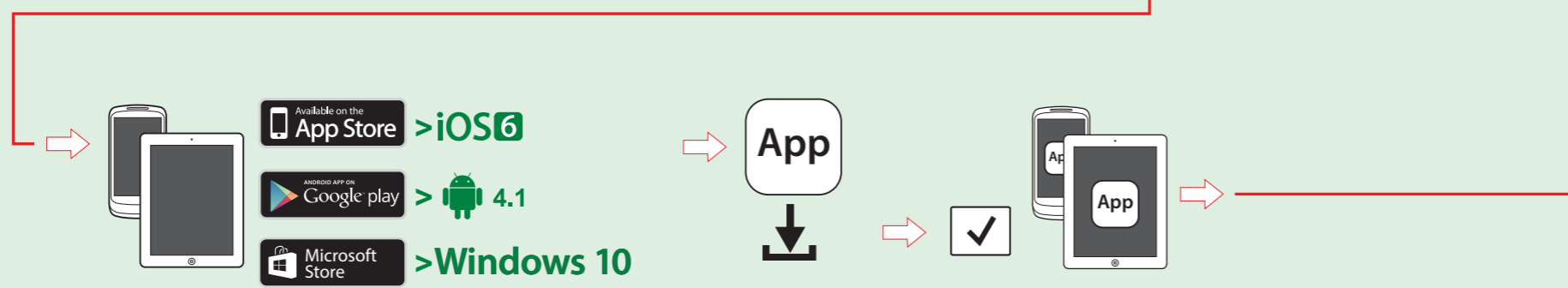

#### 6 HOW TO PAIR THE APP WITH THE ROOM UNIT?

CÓMO VINCULAR LA APP CON EL TERMOSTATO AMBIENTE  
COME ACCOPIARE LA APP A MAGO

DE APP MET DE THERMOSTAAT PAIREN  
COMMENT APPAIRER L'APPLICATION AVEC LE ROOM UNIT ?

WIE STELLE ICH EINE VERBINDUNG ZWISCHEN APP UND RAUMGERÄT HER?  
COMO EMPARELHAR A APP COM O TERMÓSTATO AMBIENTE

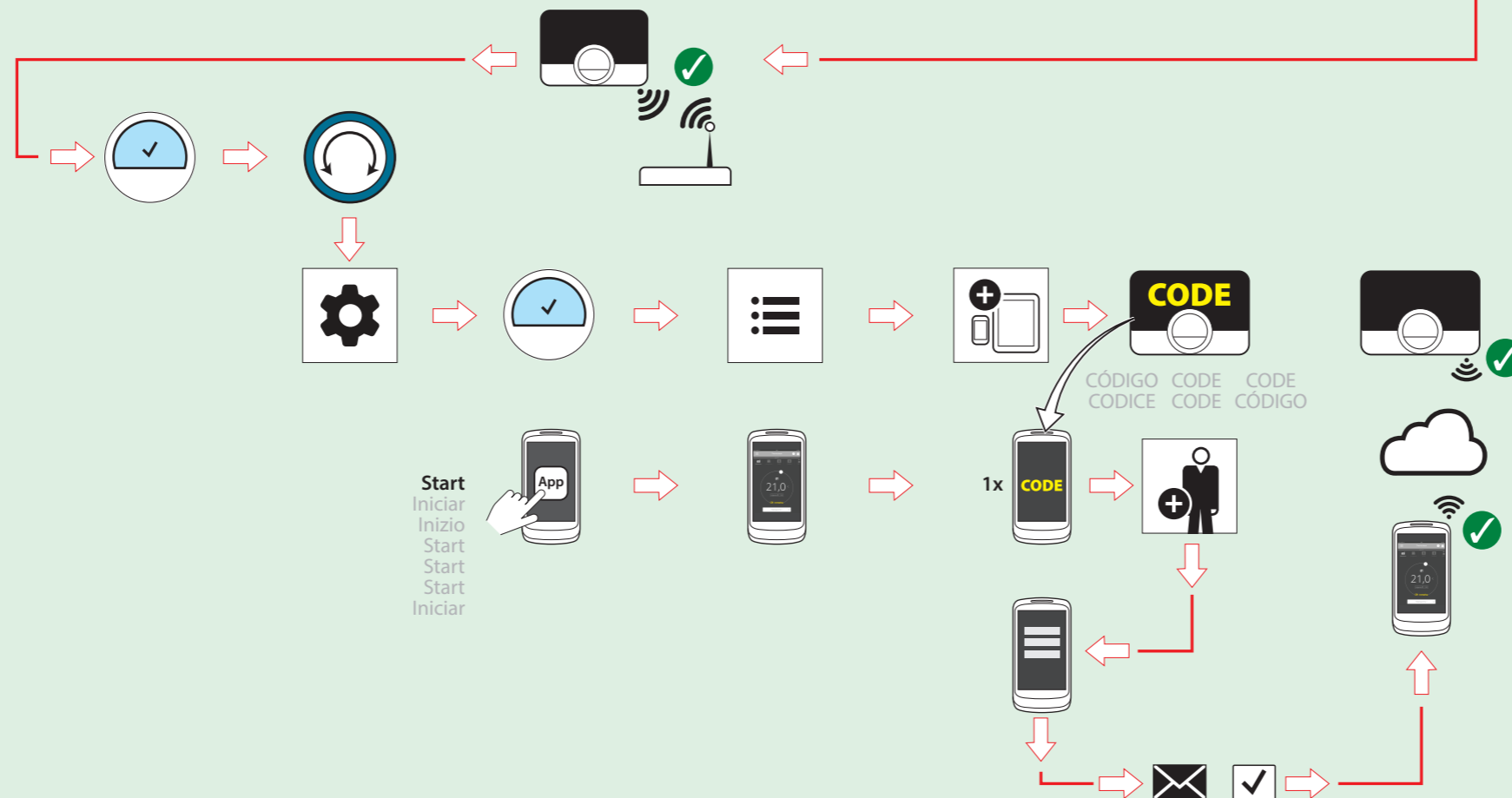

#### GLOSSARY

GLOSSÁRIO  
GLOSSARIO

LEGENDA  
GLOSSAIRE

LEGENDA  
GLOSSARIO



**Short (< 1 sec)**  
Presionar (<1 seg)  
Breve pressione (< 1 sec)  
Kort (< 1 sec)  
Court (< 1 sec)  
Kurz (< 1 sec)  
Breve (< 1 sec)



**Long (> 1 sec)**  
Mantener presionado (>1seg)  
Pressione prolungata (> 1 sec)  
Lang (> 1 sec)  
Lang (> 1 sec)  
Lang (> 1 sec)  
Longo (>1 seg)

#### Room unit icons

Icones del termostato ambiente  
Icone di Baxi Mago  
Thermostaat iconen

Les Icones du Room Unit  
Raumgerät Symbole  
Icones termostato ambiente



**Manual**  
Manual  
Funzionamento in modalità manuale  
Handmatig  
Manuel  
Handbetrieb  
Manual



**Fireplace**  
Chimenea  
Modalità "caminetto"  
Openhaard  
Cheminée  
Kamin  
Lareira



**Scheduling**  
Programación  
Funzionamento in modalità programmata  
Klokprogramma  
Programmation  
Zeitprogramm  
Programação horária



**Holiday**  
Vacaciones  
Modalità vacanza  
Vakantie  
Vacances  
Ferienprogramm  
Férias



**Frost protection**  
Protección Anti-hielo  
Funzionamento in modalità antigelo  
Vorstbeveiligd  
Hors gel  
Frostschutz  
Proteção antigelo



**Short temperature change**  
Cambio Temporal de Temperatura  
Cambio di temperatura per un breve periodo  
Tijdelijke temperatuuraanpassing  
Dérogation temporaire de temp.  
Kurzzeitige Temperaturänderung  
Alteração temperatura pontual



**Hot water boost**  
Aceleración agua caliente  
Boost Acqua Calda (dove previsto)  
Warmwater boost  
Boost Eau Chaude Sanitaire  
Warmwasser  
Forçar água quente



**Target temperature**  
Temperatura deseada  
Temperatura impostata  
Ingestelde temperatuur  
Température de consigne  
Gewünschte Temperatur  
Temperatura de ajuste



**Next step**  
Proximo Paso  
Passaggio successivo  
Volgende stap  
Etape suivante  
Weiter  
Próximo passo



**Confirm / Accept**  
Confermar / Accettare  
Conferma/accetta  
Bevestigen/accepteren  
Confirmer / Valider  
Bestätigung  
Confirmar/aceitar



**Selection**  
Selección  
Selezione  
Selectie  
Sélection  
Auswahl  
Selecionar



**Pressure**  
Presión  
Pressione  
Druk  
Pression  
Druck  
Pressão



**Home**  
Inicio  
Home  
Home  
Accueil  
Startbildschirm  
Início



**Set time**  
Definir hora  
Impostazione data/ora  
Tijd instellen  
Régler l'heure  
Einstellung Uhrzeit  
Introduzir hora



**Current temperature**  
Temperatura ambiente  
Temperatura attuale  
Gemeten temperatuur  
Température actuelle  
Aktuelle Temperatur  
Temperatura atual



**Error**  
Error  
Errore  
Fout/storing  
Erreur  
Fehler  
Erro



**Set date**  
Definir fecha  
Impostazione data/ora  
Datum instellen  
Régler la date  
Einstellung Datum  
Introduzir data



**Connect to wifi**  
Conectar a la Wi-Fi  
Connessione wi-fi  
Verbinden met wifi  
Connecter au WiFi  
Verbindung zum WiFi  
Ligar wifi



**Menu**  
Menü  
Menu  
Menu  
Menu  
Menu  
Menu



**E-mail**  
E-mail  
E-mail  
E-mail  
E-mail  
E-mail



**Settings**  
Configuración  
Impostazioni  
Instellingen  
Paramètres  
Einstellungen  
Parametrização



**Device**  
Aparato  
Caldaia/generatore  
Apparaat  
Appareil  
Gerät  
Aparelho

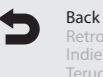

**Back**  
Retroceder  
Indietro  
Terug  
Retour  
Zurück  
Retroceder



**Register account / login**  
Registrar cuenta / Iniciar Sesión  
Registrazione / login account utente  
Account registreren / inloggen  
Créer un compte / Identification  
Nutzerkonto anlegen / Login  
Registrar conta/Iniciar sessão



**Register phone or device**  
Registrar telefono o dispositivo  
Registra dispositivo (telefono/tablet)  
Smartphone of tablet registreren  
Enregistrer téléphone ou appareil  
Mobiltelefon oder Gerät anlegen  
Registrar telefone ou aparelho